

SB00040SY Breakdown

Tank, 40 Gal Blow Molded w/Lid Lanyard Outlet Cap Gasket and Tether

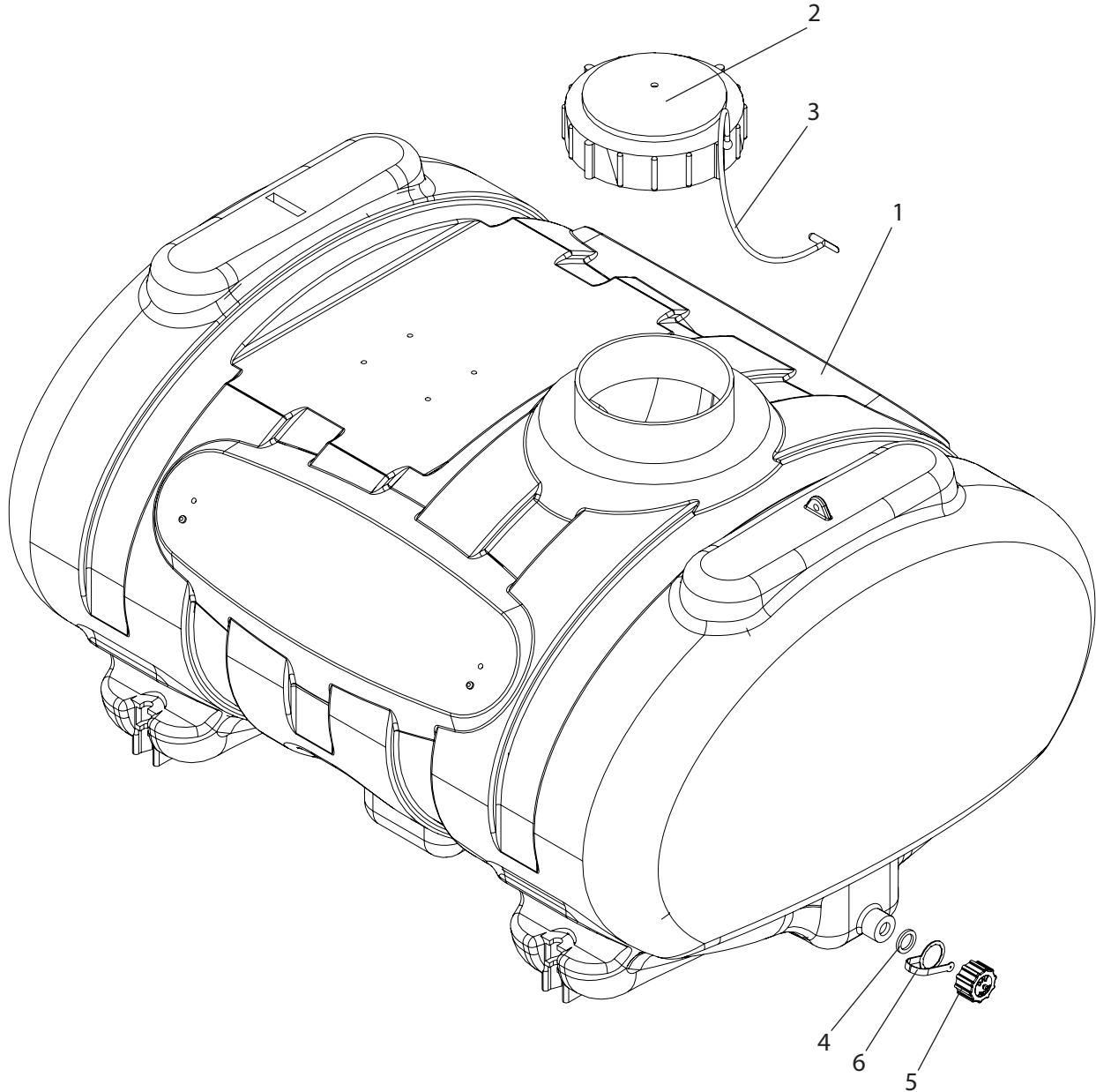

Ref#	Qty.	Part Number	Description
1	1	-----	Tank, 40 Gal Blow Molded w/Lid Lanyard Outlet Cap Gasket and Tether
2	1	10035	Lid, Tank 5" w/ out Lanyard
3	1	10873	Lanyard, 12"
4	1	10960	Gasket, Tank Outlet Cap for Den Hartog Applicator Tank
5	1	19024	Cap, Tank Outlet for Den Hartog Applicator Tank
6	1	19025	Tether, Cap Tank Outlet for Den Hartog Applicator Tank