

A304 Breakdown

Convenience Package, TR525H

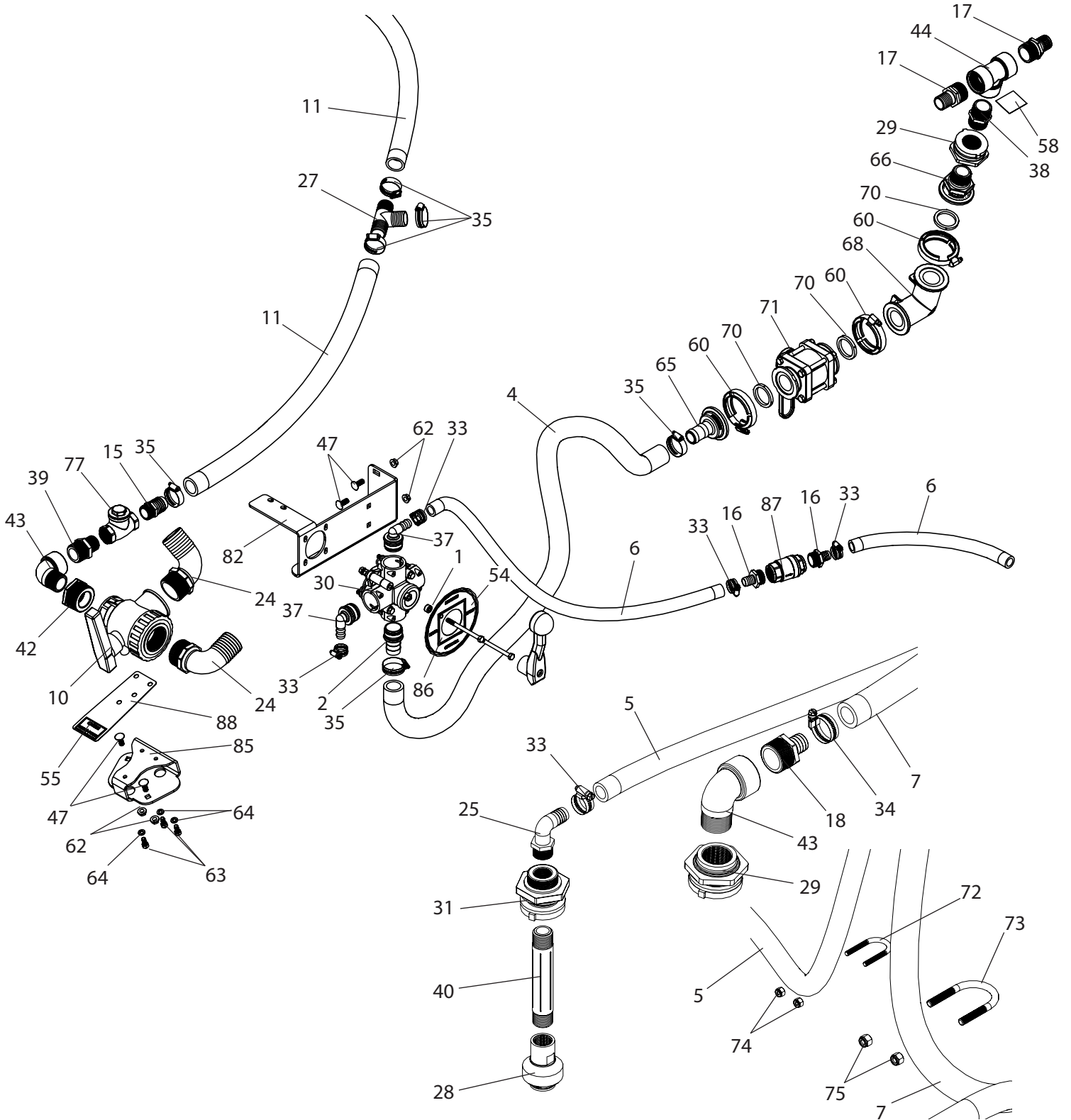

A304 Breakdown

Convenience Package, TR525H

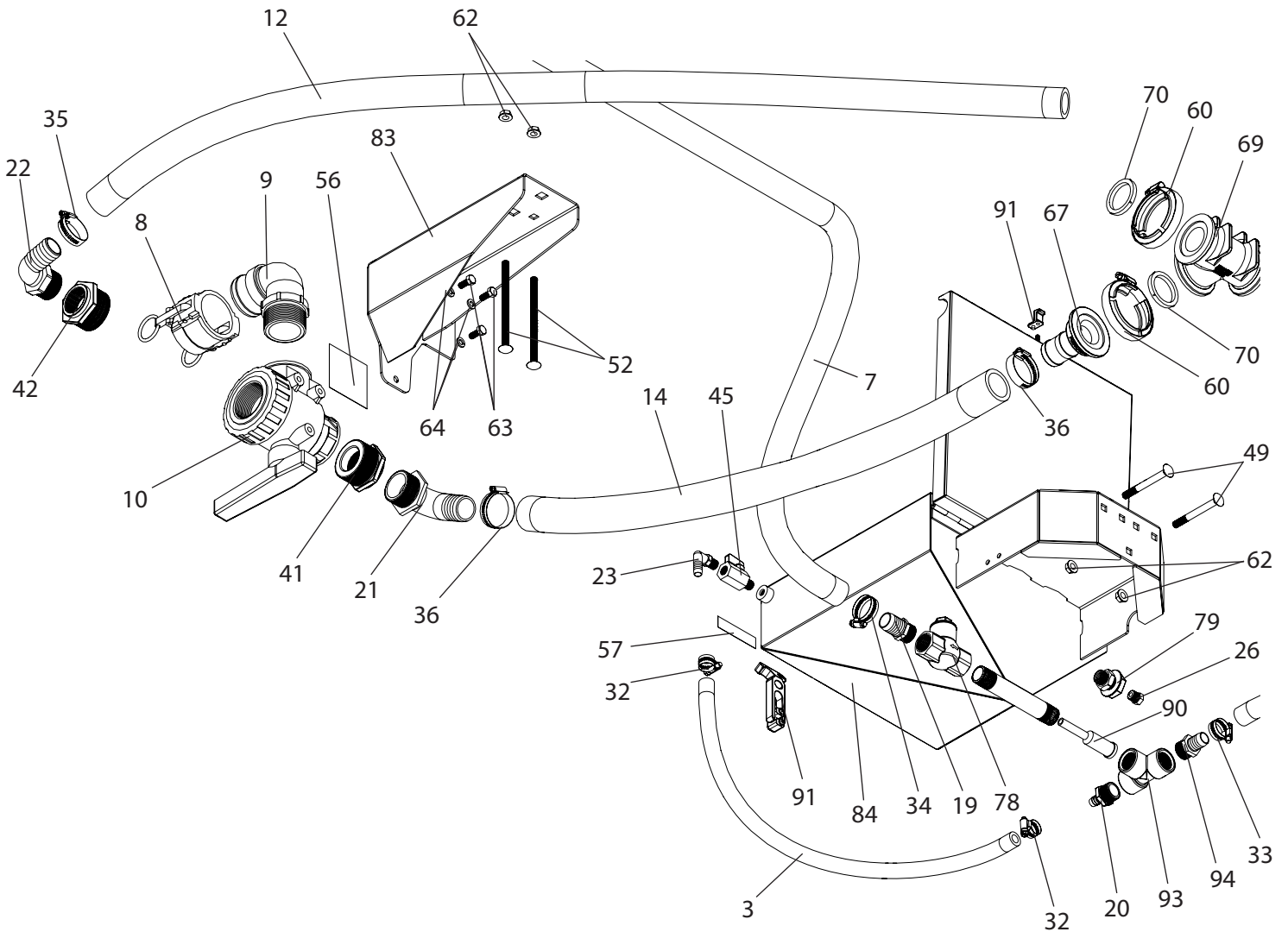

A304 Breakdown

Convenience Package, TR525H

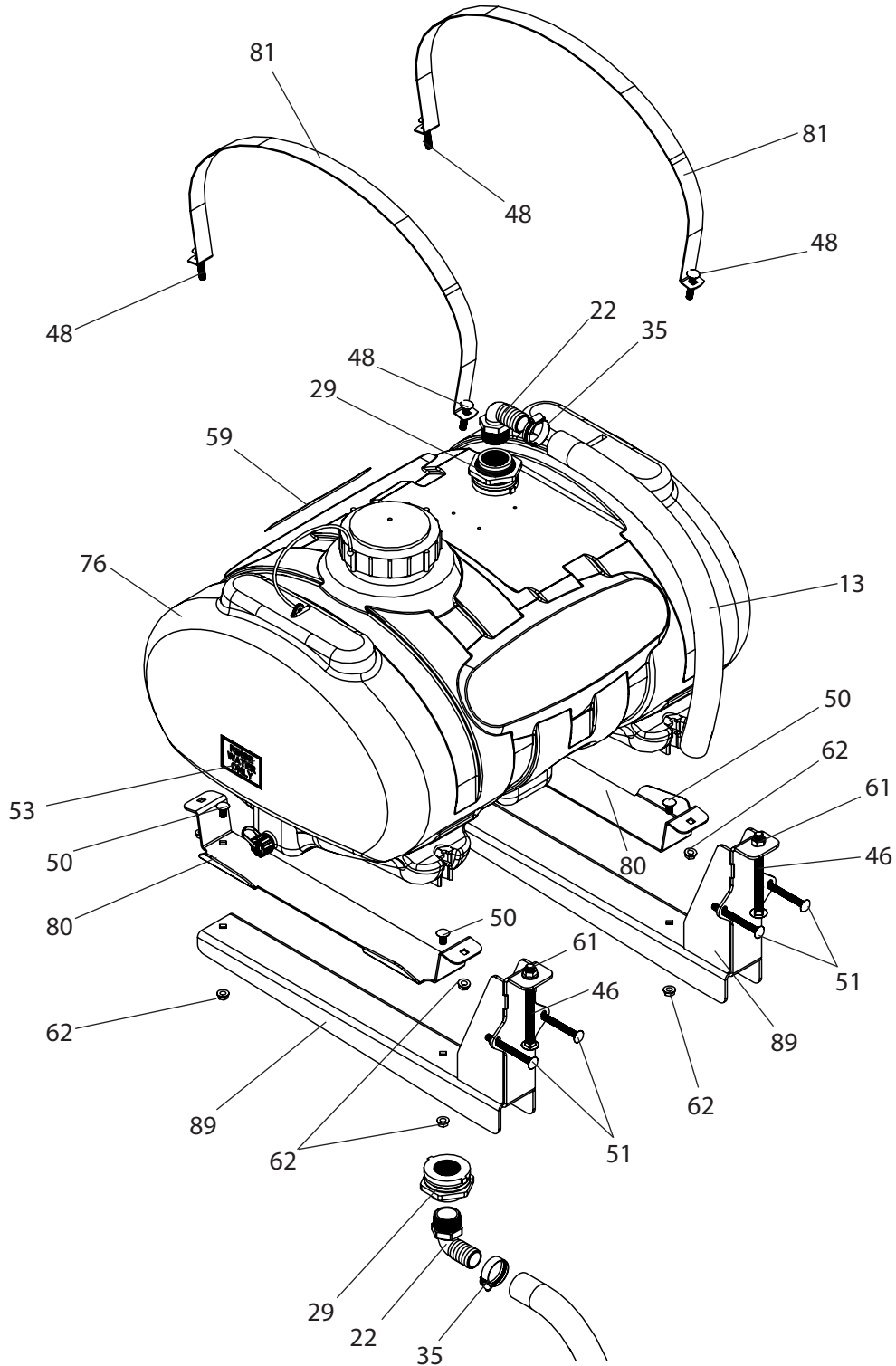

A304 Breakdown

Convenience Package, TR525H

Ref#	Qty.	Part Number	Description
1	2	0313P	Shaft Collar, 5/16"
2	1	04581	Fitting, QC 1-1/4" HB x 1-1/4" QC
3	2.5FT	1008	Hose, EPDM Rubber 1/2" 300 PSI
4	6FT	10104	Hose, EPDM Rubber 1-1/4" 150 PSI
5	20.5FT	1012	Hose, EPDM Rubber 3/4" 300 PSI
6	7FT	1012	Hose, EPDM Rubber 3/4" 300 PSI
7	15FT	1016	Hose, EPDM Rubber 1" 300 PSI
8	1	200DCS	Dust Cap, 2" Male Coupler
9	1	200LF	Coupler, 2" Male w/2" MPT 90°
10	2	200SUBV3	Valve, Ball 3-Way Union 2" FPT
11	6FT	3111	Hose, Suction EPDM Blend 1-1/4" 70 PSI
12	6.5FT	3111	Hose, Suction EPDM Blend 1-1/4" 70 PSI
13	2.2FT	3111	Hose, Suction EPDM Blend 1-1/4" 70 PSI
14	2.7FT	3112	Hose, Suction EPDM Blend 1-1/2" 60 PSI
15	1	3A100114	Fitting, Hose 1" MPT x 1-1/4" HB
16	2	3A10034	Fitting, Hose 1" MPT x 3/4" HB
17	2	3A114	Fitting, Hose 1-1/4" MPT x 1-1/4" HB
18	1	3A114100	Adapter, Hose 1-1/4" MPT x 1" Barb
19	1	3A34100	Fitting, Hose 3/4" MPT x 1" HB
20	1	3A3412	Fitting, Hose 3/4" MPT x 1/2" HB
21	1	3EL112	Elbow, Hose 90° 1-1/2" MPT x 1-1/2" Barb
22	3	3EL114	Elbow, Hose 90° 1-1/4" MPT x 1-1/4" Barb
23	1	3EL1412	Elbow, Hose 90° 1/4" MPT x 1/2" HB
24	2	3EL200	Adapter, Hose 90° 2" MPT x 2" HB
25	1	3EL3434	Adapter, Hose 90° 3/4" MPT x 3/4" HB
26	1	3F14	Plug, 1/4" MPT Poly
27	1	3T114	Tee, Fitting 1-1/4" HB Poly
28	1	55270-3/4-18-POM	Nozzle, Tank Rinse 3/4" FPT Black
29	4	60403	Fitting, Bulkhead 1-1/4" FPT Dbl Tap (Requires 2-1/4" Hole)
30	1	61128*	Valve, Ball 1-1/4" 5-Way
31	1	62798	Fitting, Tank 3/4" FPT Dbl Tap (Requires 1-5/8" Hole)
32	2	6806052	Hose Clamp, 1/2" - 29/32" SS
33	6	6812052	Hose Clamp, 11/16" - 1-1/4" SS
34	2	6816052	Hose Clamp, 13/16" - 1-1/2" SS
35	9	6820052	Hose Clamp, 13/16" - 1-3/4" SS
36	2	6824052	Hose Clamp, 1-1/16" - 2" SS
37	2	80352	Elbow, 3/4" HB to 1-1/4" Quick Fitting
38	1	8M114	Nipple, 1-1-4" MPT x Close Sch 80 Poly
39	1	8M1141	Nipple, Reducer 1-1/4" MPT x 1" MPT Sch 80 Poly
40	1	8M34*6	Nipple, 3/4" MPT x 6" Sch 80 Poly

*Has component part breakdown.

A304 Breakdown

Convenience Package, TR525H

Ref#	Qty.	Part Number	Description
41	1	8RB200112	Bushing, Reducer 2" MPT x 1-1/2" FPT Sch 80 Poly
42	2	8RB200114	Bushing, Reducer 2" MPT x 1-1/4" FPT Sch 80 Poly
43	2	8SE114	Elbow, Street 90° 1-1/4" NPT Sch 80 Poly
44	1	8TT114	Tee, Poly 1-1/4" FPT Sch 80
45	1	90FMB14	Valve, Ball 1/4" FPT x 1/4" MPT 300 PSI
46	2	CB12*6G5	Bolt, Carriage 1/2-13 x 6" Gr 5
47	4	CB38*1G5	Bolt, Carriage 3/8-16 x 1" Gr 5
48	4	CB38*2G5	Bolt, Carriage 3/8-16 x 2" Gr 5
49	2	CB38*312G5	Bolt, Carriage 3/8-16 x 3-1/2" Gr 5
50	4	CB38*34G5	Bolt, Carriage 3/8-16 x 3/4" Gr 5
51	4	CB38*4G5	Bolt, Carriage 3/8-16 x 4" Gr 5
52	2	CB38*6G5	Bolt, Carriage 3/8-16 x 6" Gr 5
53	1	DE100	Decal, Rinse Water Only
54	1	DE101	Decal, Main Valve
55	1	DE102	Decal, Suction Valve Trailer
56	1	DE106	Decal, Quick Fill Valve
57	1	DE112	Decal, Education Rinse
58	1	DE118	Decal, Quick Fill Valve
59	1	DE46	Decal, CropCare Logo 1.9" x 8.8"
60	5	FC200	Clamp, Flange 2" Std SS
61	2	FN12	Nut, Flange 1/2-13
62	20	FN38	Nut, Flange 3/8-16
63	6	H5C516*34	Bolt, Hex 5/16-18 x 3/4" Gr 5
64	6	LW516	Washer, Lock 5/16"
65	1	M200125BRB	Fitting, Flange 1-1/4" HB x 2" Flange
66	1	M200125MPT	Adapter, 2" Flange x 1-1/4" MPT
67	1	M200150BRB	Fitting, Flange 1-1/2" HB x 2" Flange
68	1	M200CPG90	Coupling, 90° 2" Flange x 2" Flange
69	1	M200TEE	Tee, Flange 2" Flanged Fitting
70	5	M201G	Gasket, Manifold EPDM 2" w/Rib
71	1	MV200CF	Valve, Ball Bolted 3 Way Side Load 2" Std Port x 2" Flange
72	1	N222083	Bolt, U-Bolt Round 1/4-20 x 1-1/8" x 2-1/4" Zinc
73	1	N222190	Bolt, U-Bolt Round 3/8-16 x 2" x 3-1/2" Zinc
74	2	NNC14	Nut, Lock Nylon 1/4-20
75	2	NNC38	Nut, Lock Nylon 3/8-16
76	1	SB00040SY *	Tank, 40 Gal Blow Molded w/Lid Lanyard Outlet Cap Gasket and Tether
77	1	SCV15	Valve, Check Swing 1" FPT 200 PSI SS
78	1	SCV34S	Valve, Swing Check 3/4" FPT 200 PSI SS
79	1	SKU28315	Fitting, Bulkhead Brass 1/4" NPT Female to Male
80	2	T722	Bracket, Mounting 40 & 60 Gallon Tanks

*Has component part breakdown.

A304 Breakdown

Convenience Package, TR525H

Ref#	Qty.	Part Number	Description
81	2	T723	Tank strap for 40gal DenHartog tank
82	1	T849	Valve mount plate, high pressure
83	1	T851	Quick fill mount bracket
84	1	T852	Chemical eduction tank, 1 1/4" MPT, stainless
85	1	T858	Suction Valve Mount Tube
86	1	T859	Plate, Valve Label
87	1	T873	Valve, Check 1" FPT SS/Viton 10 PSI
88	1	T882	Suction valve label plate, trailers
89	2	T884	Rinse water tank bracket, 500/750 gallon trailer
90	1	T894	Eduction Jet, 9/32" Orifice, 4 1/16" long
91	1	WJ215	Latch, Rubber Draw w/Screws
92	1	3A3434	Fitting, Hose 3/4" MPT x 3/4" HB
93	1	8TT34	Tee, Poly 3/4" FPT Sch 80

*Has component part breakdown.